

**Thermoelectric Air Conditioner
Heating & Cooling Unit
ACAC 600 BTU Ex Proof
for hazardous environment**

**Explosion Proof Rating ATEX Zone 2 T5
Dust and Water Protection Standard IP54**

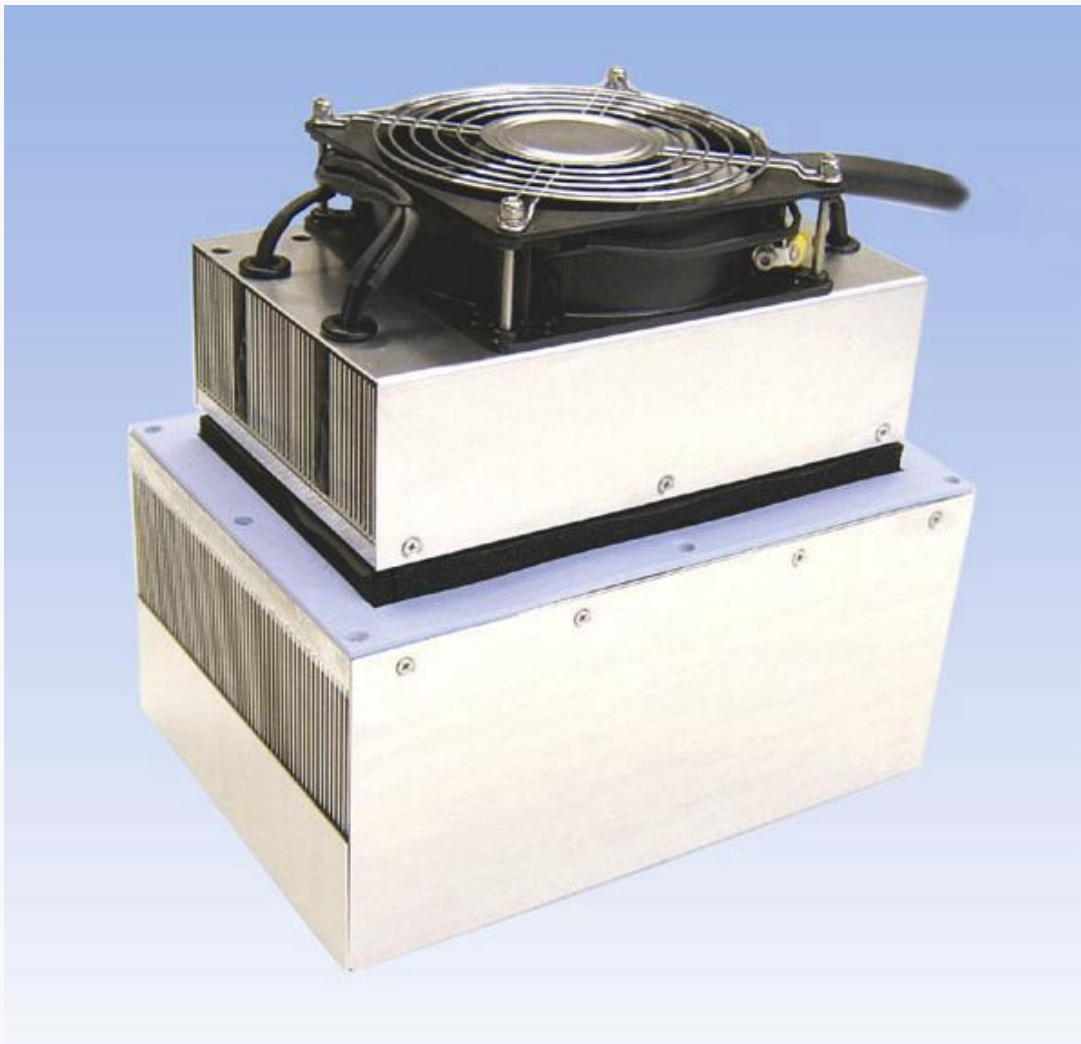

INHECO part number: 8700001

► Performance curve for ACAC 600 BTU Ex Proof

Cooling Data

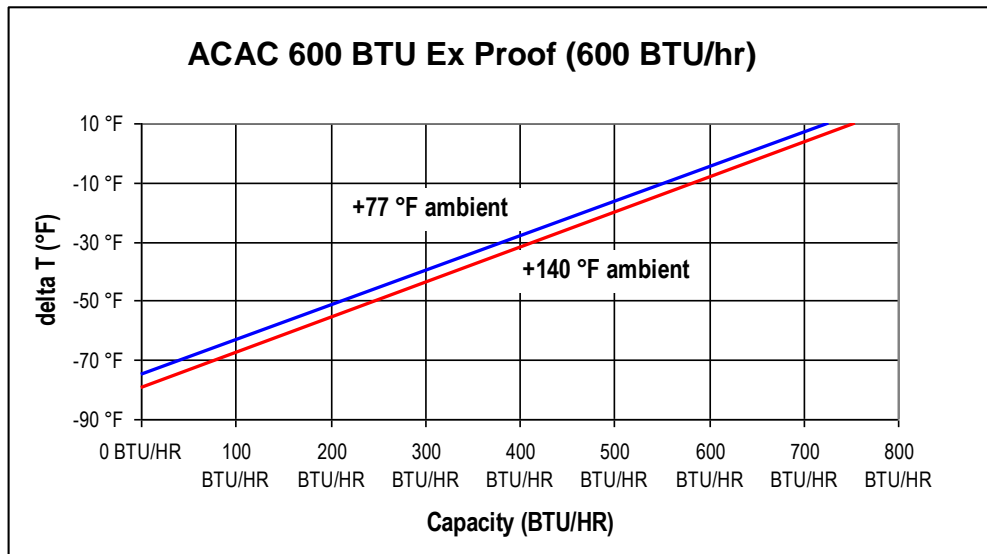
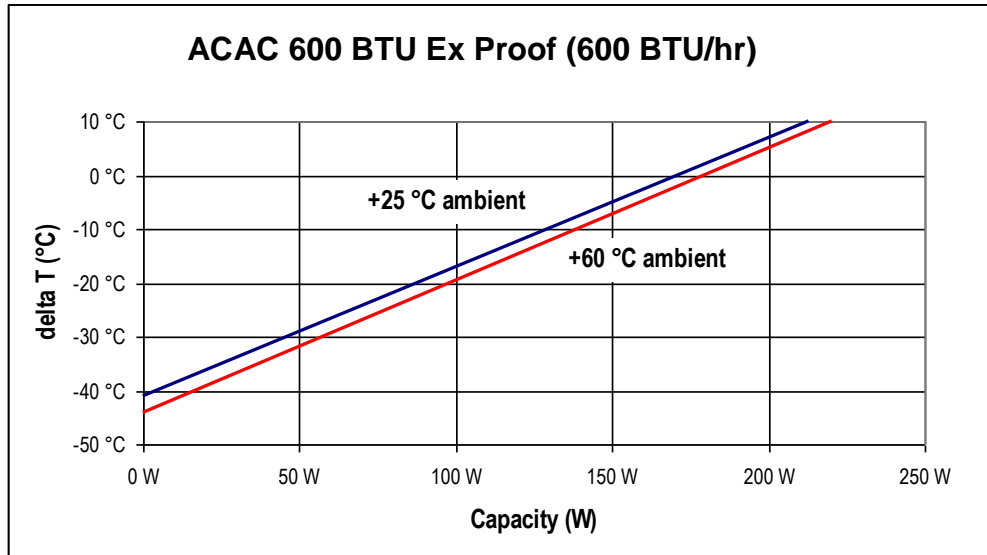

Heating Data

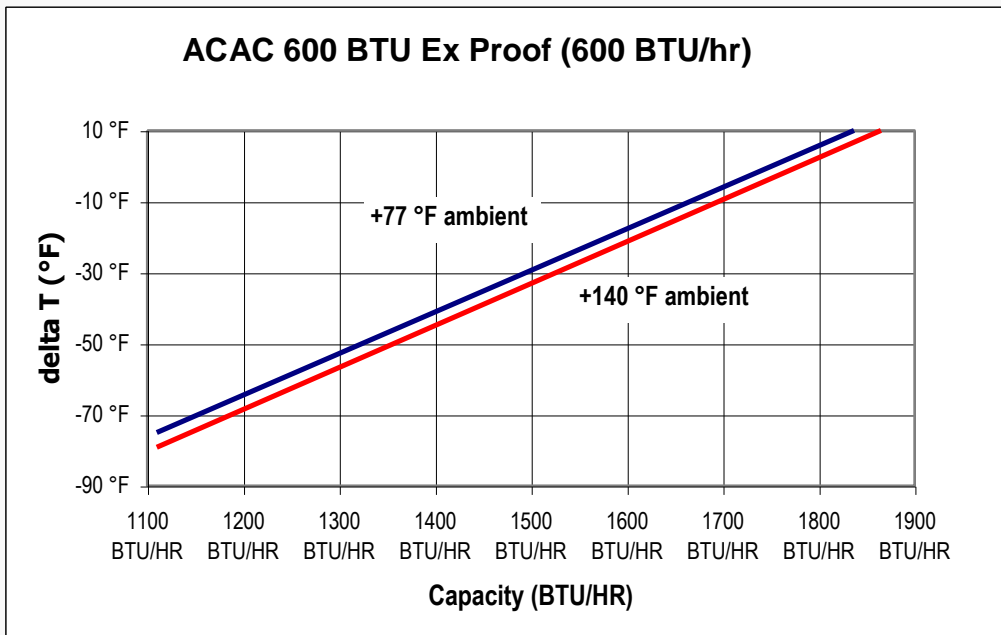
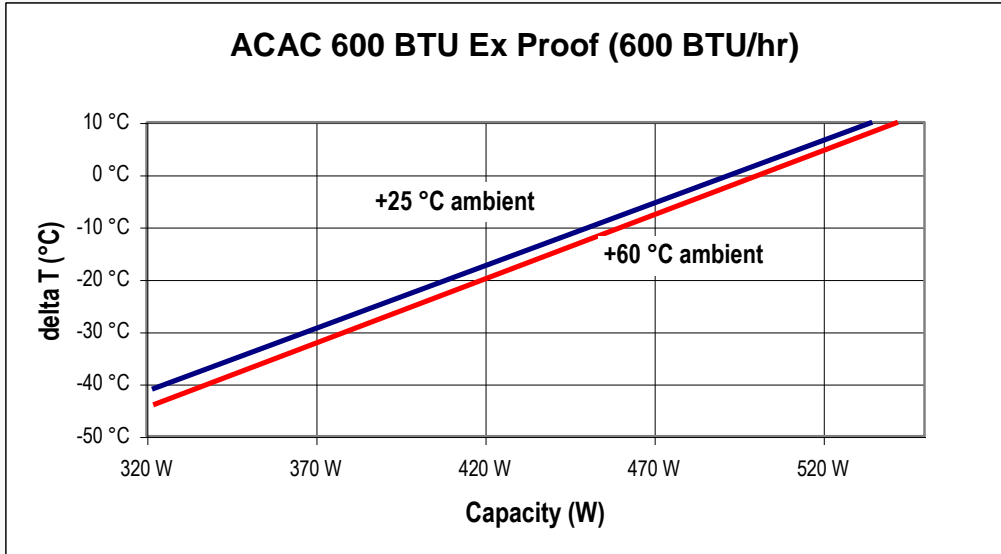

► **Dimensions ACAC 600 BTU Ex Proof**

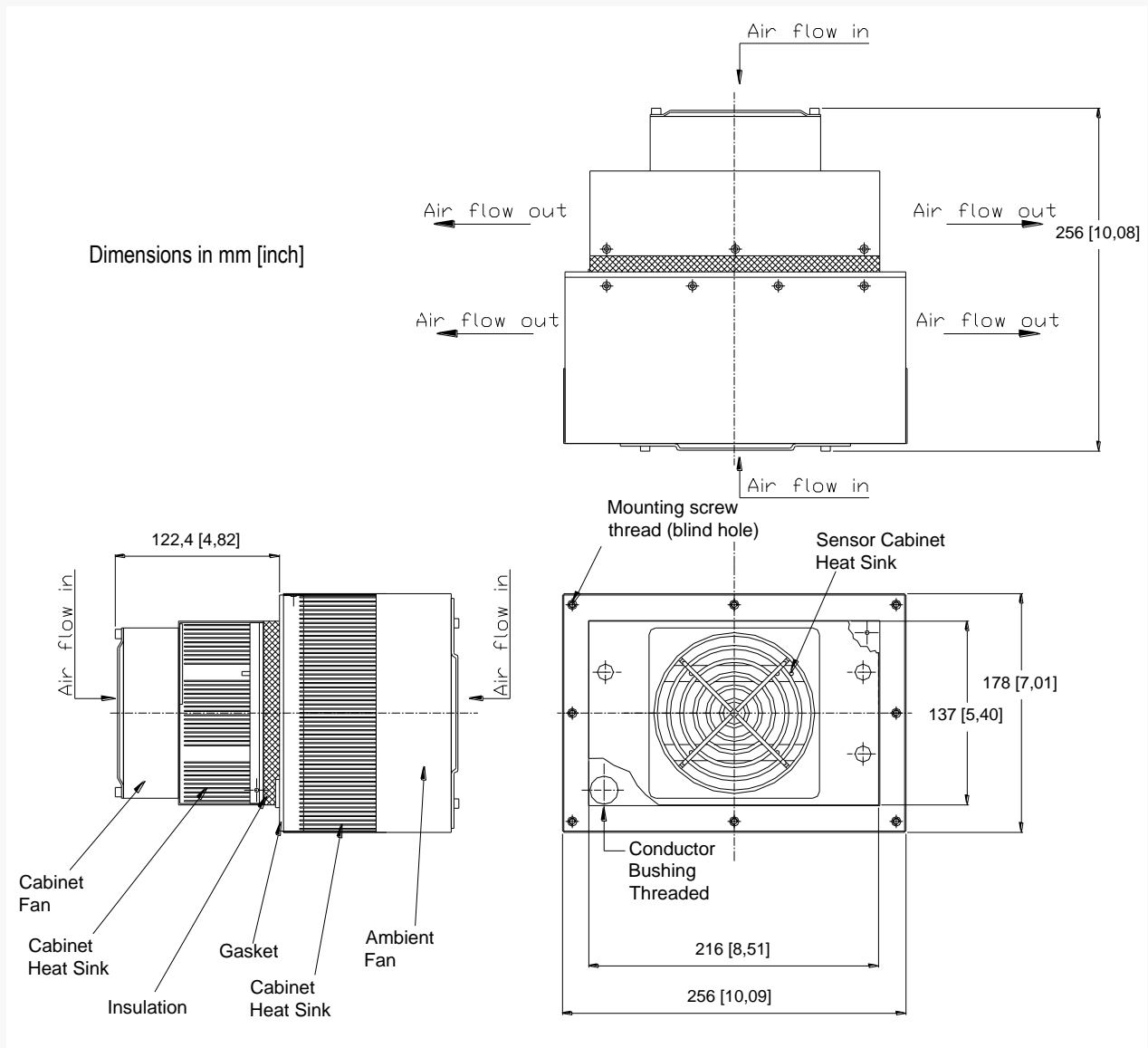

► **Features:**

- **gasket certified ATEX Zone 2 T5**
- **temperature sensor**
- **safety switch / thermal fuse for over-temperature**
- **drip pan on request**

▶ Technical Specifications ACAC 600 BTU Ex Proof

Electric Data	
Nominal Capacity at +25°C (+77 °F) ambient and $\Delta T = 0^\circ\text{C}$ (0°F)	176 W (600 BTU / hr)
Supply Voltage U_i	24 Vdc
Running Current Cooling Mode	15 Adc continuous
Running Current Heating Mode	15 Adc continuous
Maximum power consumption (not steady state)	480 W @ 24Vdc
Max. Ambient Temperature	+49°C (+120°F)
Min. Ambient Temperature	-40°C (-40°F)
Enclosure Fan Air Flow	250 m ³ /h (147.2 CFM)
Ambient Fan Air Flow	410 m ³ /h (241.3 CFM)
Weight	9,4 kg (20,7 lb)
Ratings certified by TÜV Product Service, Germany	CE,  3G EEX nA IIA T5 X
Main Dimensions	H 254 mm x W 178 mm x D 244 mm (H 10" x W 7" x D 9.6")

INHECO
Industrial Heating & Cooling GmbH
 Fraunhoferstrasse 11
 82152 Martinsried
 Phone +49 (0)89 899593-101
 Fax +49 (0)89 899593-149
 email sales@inheco.com

Website  www.inheco.com