

**Magnetic Shaker
TELESHAKE with
SHAKEMODUL
Operating Manual**
50134813 Issue 03.2012



Analyze • Detect • Measure • Control™

Thermo
SCIENTIFIC

© 2012 Thermo Fisher Scientific Inc. All rights reserved.

DURAN® is a trademark of SCHOTT AG.

All other trademarks are the property of Thermo Fisher Scientific Inc and its subsidiaries.

Specifications, terms and pricing are subject to change.

Not all products are available in all countries.

Please consult your local sales representative for details.

Dissemination and copying of this document, utilization and information of its content are not allowed, unless specifically authorized. Violations commit you to compensation.

Subject to change without notice.

No liability assumed for literal mistakes

Thermo Electron LED GmbH is legal successor of H+P Labortechnik AG.

Thermo Electron LED GmbH

Robert-Bosch-Straße 1
D-63505 Langenselbold

Germany national toll free:

Phone Sales: 0800 1536376

Phone Service 0800 1112110

Fax: 0800 1112114

Germany international:

Phone: +49 6184 906940

Fax: +49 6184 906772

E-mail: info.labequipment.de@thermofisher.com

For further help see: www.thermofisher.com

Contents

	Page
Assembly drawings	4
User considerations	4
1 Safety considerations	5
2 Equipment description	7
3 Function	8
4 Startup procedure	9
5 Manual operation	11
5.1 Tips for shaker operation	12
6 operation	13
6.1 Controlling a single magnetic shaker	13
6.2 Controlling several magnetic shakers	14
7 Maintenance and cleaning	21
8 Troubleshooting	22
9 Technical specifications	23
10 Warranty	20

Assembly drawings

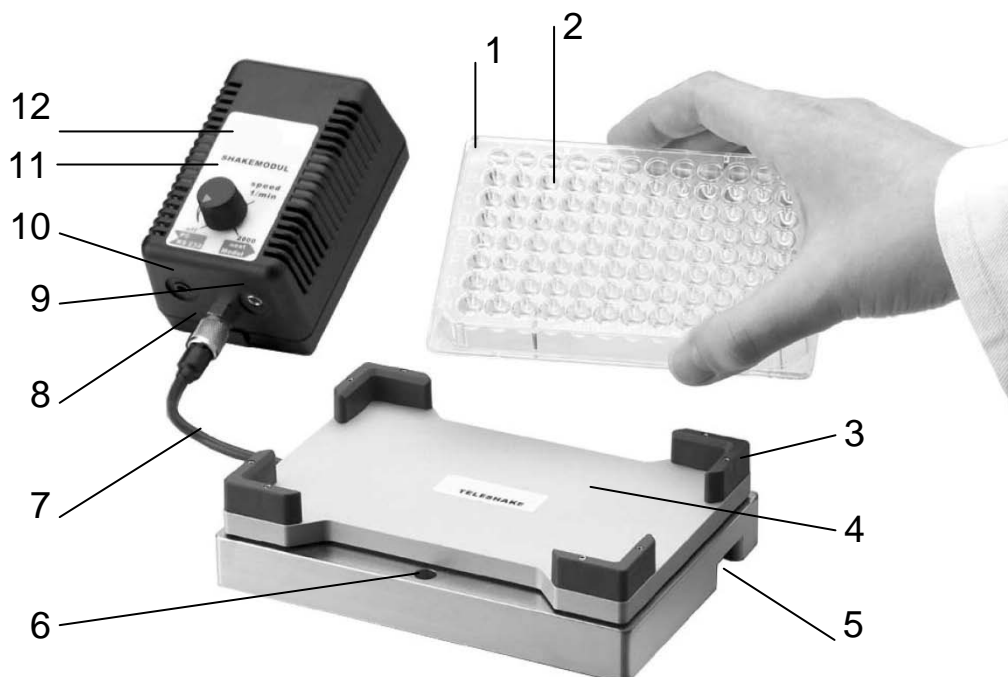

- | | | | |
|---|------------------|----|------------------------------------|
| 1 | Microtitre plate | 7 | Control line |
| 2 | Well | 8 | Control line connector |
| 3 | Fixating angle | 9 | Jack socket, blue (to next module) |
| 4 | TELESHAKE | 10 | Jack socket, red (to PC RS232) |
| 5 | Cable duct | 11 | Frequency selection knob |
| 6 | Mounting holes | 12 | SHAKEMODUL |

Figure 1: TELESHAKE magnetic shaker with SHAKEMODUL control unit

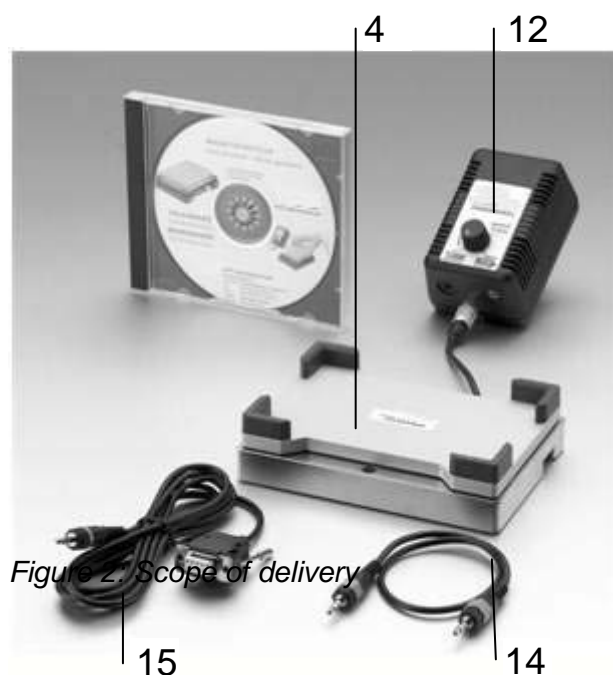

Figure 2: Scope of delivery

Scope of delivery

- 4 TELESHAKE magnetic shaker
- 12 SHAKEMODUL control unit
- 14 RS232 Module connecting cable # 50095805
- 15 RS232 Interface cable # 50095807
- 16 TELESHAKE testing program (CD-ROM)

Operating manual (without picture)

Interface description:

RS232 Communication protocol
(without picture)

1/2" Allen wrench (without picture)

User considerations

Correct use

The remote-controlled TELESHAKE is used for shaking liquids in tissue culture plates and microtitre plates.

The microtitre plates can be employed for chemical, microbiological, biotechnical, pharmaceutical or medical purposes.

They are suited to operation on laboratory workbenches and robot stations.

Incorrect use

The TELESHAKE must not be operated in hazardous locations.

Do not shake flammable liquids with a low boiling point.

The TELESHAKE must not be operated in a water bath.

Swashed over or spilled liquid has to be removed immediately.

Pictographs

You will find the following pictographs in this operating manual:



DANGER

This sign refers to dangerous voltages.

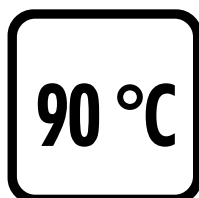

DANGER

This sign refers to hazardous situations. Hazards to human life are indicated by "LIFE HAZARD".

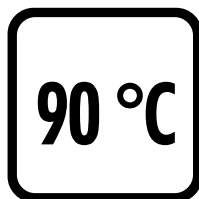

CAUTION

This sign indicates danger to equipment and machinery.

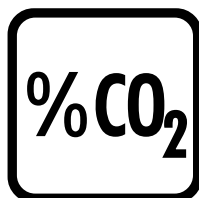

INFORMATION

This sign indicates easier working practices.



Indicates an operating step.



Indicates alternatives.

1 Safety considerations

For your own safety, you should observe the following safety warning signs.

The warning signs indicate potential sources of danger. They also inform on how correct action can avert danger. You will always find these warning signs attached to points of possible danger.

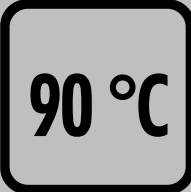
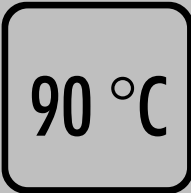
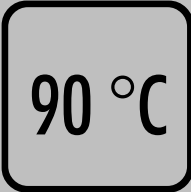
	<p>DANGER</p> <p>Magnetism. Magnetic or metallic parts (e.g. data carriers, pace-makers, watches) can be affected by magnetic fields. Keep such parts away from the TELESHAKE.</p>
	<p>CAUTION</p> <p>The unit must not be operated in hazardous locations.</p>
	<p>CAUTION</p> <p>In case of repair, the equipment must only be opened by an authorised service agent.</p>

2 Equipment description

Figure 1 shows the components together with their position numbers. Figure 2 shows the scope of delivery.

The remote-controlled TELESHAKE magnetic shaker (4) consists of a drive block with a shaker platform for a microtitre plate (1). The four corners of the shaker platform feature fixating angles (3) to keep microtitre plates (1) in place. The TELESHAKE (4) can be firmly mounted in place (e.g. on the laboratory workbench, robot station). The mounting holes (6) on the long sides of the TELESHAKE (4) and the M3-threaded bores (13) at the bottom of the unit are used for this purpose. The bottom also features cable ducts (5) allowing you to run the control line (7) to the control unit (12) while keeping it protected and free of kinks.

The SHAKEMODUL (12) serves as a power supply and control unit for the TELESHAKE magnetic shaker (4). The control line (7) of the TELESHAKE (4) is connected to the control line connector (8) of the SHAKEMODUL control unit (12).

The shaking frequency (100 to 2,000 rpm) is continuously adjustable. It can be adjusted using the frequency selection knob (11).

The power draw during operation is less than 1 watt. This means that neither the unit nor the microtitre plates (1) will be heated. This is why TELESHAKE (4) is ideal for the use in incubators and laminar-flow systems under suitable operating conditions (see chapter 9, Technical specifications).

The unit can also be remote-controlled using the RS232 interface, addressing the control unit (12) from a PC or robot.

The rotation direction and the shaking mode (circular or back and forth) as well as the required intervals can be selected by software.

Up to 14 TELESHAKE units (4) with SHAKEMODUL (12) can be controlled directly and individually via a single RS232 interface.

3 Function

The remote-controlled TELESHAKE magnetic shaker (4) is used for shaking liquids in tissue culture plates and microtitre plates (1). Its design is flat (39 mm), making it only slightly larger than a microtitre plate (1). The unit is easily integrated in robot stations.

To do so, it is necessary to mount the TELESHAKE (4) in a fixed position in a precisely specified location. This can be effected using the threaded bore holes (M3) (13) at the bottom or – from above – using the two mounting holes (6) on the long sides of the TELESHAKE (4).

The microtitre plate (1) is placed on the shaker platform of the TELESHAKE (4). The liquid to be shaken is introduced into the microtitre wells (2).

The automatic start up function of the unit ensures a gradual start of the shaking process, without sample splashing. Its inductive drive is absolutely wear-free and maintenance-free.

When turned off, the shaker platform automatically returns to its centric position (auto-positioning); no expensive electrical repositioning mechanism is needed. This feature ensures safe performance even during unsupervised continuous operation.

4 Startup procedure



DANGER

Supply voltage and supply frequency must be within the range specified for the SHAKEMODUL (12). The SHAKEMODUL (12) must only be connected to an earthed socket.

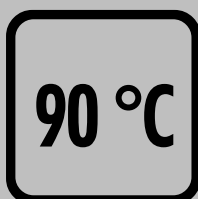

DANGER

Magnetism.
Magnetic or metallic parts (e.g. data carriers, pace-makers, watches) can be affected by magnetic fields. Keep such parts away from the TELESHAKE (4).

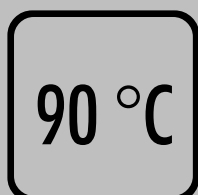

CAUTION

The equipment must not be operated in hazardous locations.

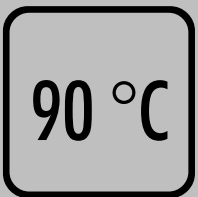

CAUTION

Make sure that the filling of the wells (filling level) and the selected shaking frequency prevent spilling of liquid during shaking.

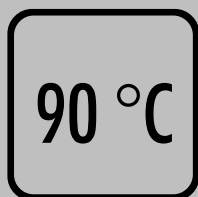

CAUTION

Permissible ambient conditions:
Cf. Technical specifications.
Avoid extreme temperature changes.
The TELESHAKE (4) and the SHAKEMODUL (12) must not be run in humid rooms, or set up in water splash zones.

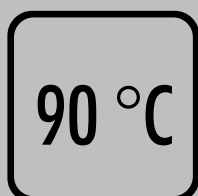

CAUTION

The frequency selection knob (11) of the SHAKEMODUL (12) must be set to OFF before connecting or disconnecting any cable.

For safe operation, e.g. when integrating the TELESHAKE (4) into a robot station, the unit must be mounted in a fixed position in a precisely specified location. To do so, use the mounting holes (6) on the long sides of the TELESHAKE (4) or the threaded bore holes (M3) at the bottom (13).

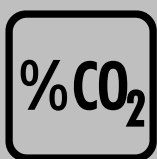

INFORMATION

We recommend removing the rubber feet on the bottom before mounting the TELESHAKE (4). In this way, you can mount the TELESHAKE (4) so that it is protected from vibrations. The shaking performance is improved then, and residual heat is transported off through contact with the mounting surface.

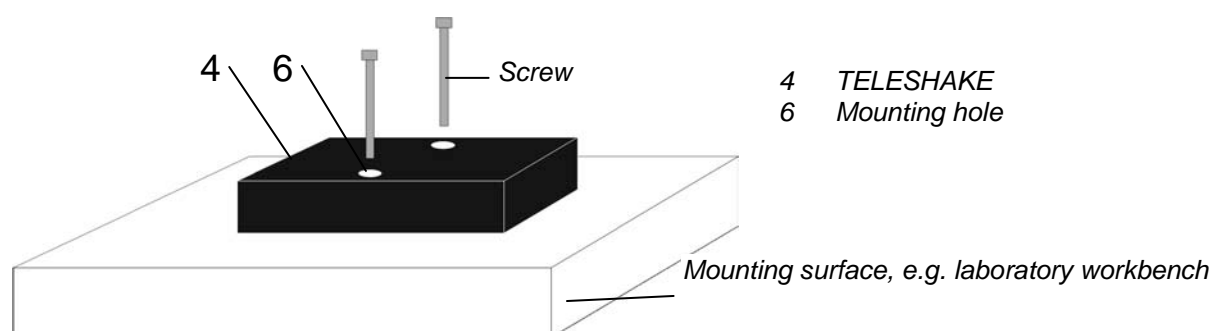

Figure 3: Mounting the TELESHAKE using the mounting holes

Insert the screws into the mounting holes (6) from above and screw them firmly into the mounting surface (Figure 3).

Or use the threaded bore holes (M3) (13) to attach the TELESHAKE (4) to the workbench from below (Figure 4).

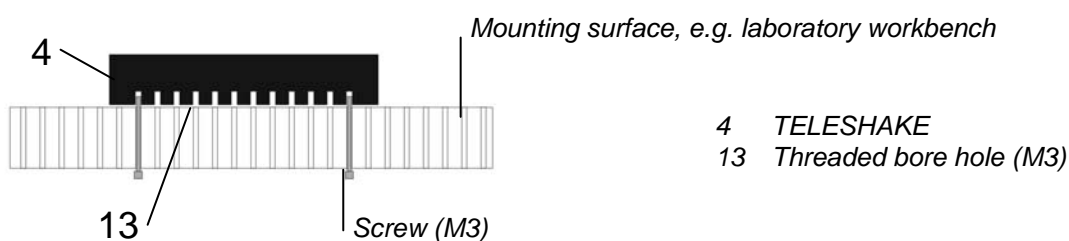

Figure 4: Mounting the TELESHAKE using the threaded bore holes (M3)

- ◆ Use a sharp object to remove the four rubber feet at the bottom of the TELESHAKE (4).
- ◆ Mount the TELESHAKE (4) on the mounting surface (see Figure 3 and Figure 4).

5 Manual operation

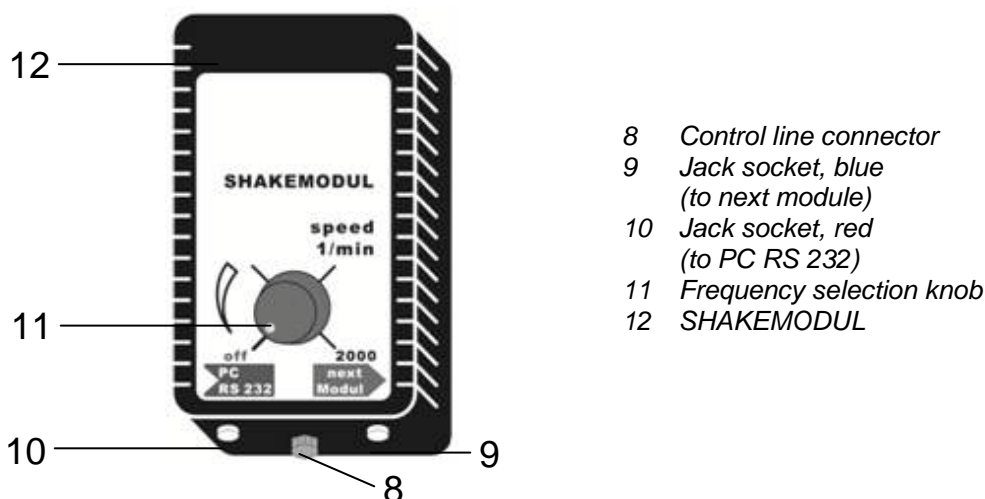

Figure 5: SHAKEMODUL control unit

- ◆ Turn the frequency selection knob (11) on the SHAKEMODUL (12) to OFF (Figure 1 and Figure 5).
- ◆ Plug the control line (7) of the TELESHAKE (4) into the control line connector (8) of the SHAKEMODUL (12). Tighten the knurled screw.
- ◆ Plug the mains cable of the SHAKEMODUL (12) into a socket outlet.

INFORMATION

⚠ When filling microtitre plates (1), make sure the wells (2) are not filled to the rim. Otherwise, some sample splashing might occur.

- ◆ Introduce the liquid to be shaken into the microtitre wells (1).
- ◆ Place the prepped microtitre plate (1) on the TELESHAKE (4).
- ◆ Attach the microtitre plate (1) using the fixating angles (3) of the TELESHAKE (4). Please use the ½" Allen wrench (included).
- ◆ Use the frequency selection knob (11) to select the shaking frequency.

When in operation, the TELESHAKE (4) will only perform a circular movement in one direction (vortex operation) around its centric position (zero position). When turned off, the TELESHAKE (4) will reproducibly return to this position.

5.1 Tips for shaker operation

A wide variety of microtitre plates is commercially available.

To position the plates accurately and to keep them in place, use the adjustable fixating angles (3) of the shaker platform (see above). For robot operation, adjust the fixating angles (3) so that the microtitre plate can drop onto the shaker platform with no leeway on either side. Alternatively, you might adjust the fixating angles (3) so that the microtitre plate is firmly pressed onto the shaker platform.

In general, the mixing performance of microtitre plates with rectangular wells is better than the mixing performance of microtitre plates with cylindrical or conical wells.

384-well or 1536-well microtitre plates with conical wells are less suitable for very high shaking frequencies.

If the filled microtitre plate has a weight of more than 200 g, the maximum rated shaking frequency of 2,000 rpm may not be attainable. Select a lower shaking frequency in this case. However, there is **no risk** of damage to the TELESHAKE magnetic shaker (4) – even if the weight is higher or if shaking action stops due to excessive weight or excessive shaking frequencies. As soon as you reduce the frequency, the unit will start up again automatically.

Maximum shaker platform load: 500 g (filled microtitre plate).

6 Remote operation

You may also control the TELESHAKE (4) remotely from your PC or robot using the RS232 interface. This will permit you to adjust, in addition to shaking frequency, other parameters such as running time, shaking mode, or shaking sequences (see chapter 6.3). Up to 14 TELESHAKE units (4) with SHAKEMODUL (12) can be controlled directly and individually via a single RS232 interface.

For detailed description of the RS232 communication protocol see enclosed interface description (Order number 50109812)

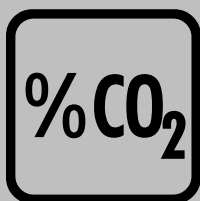

INFORMATION

PC or robot control is only available if the frequency selection knob (11) is set to OFF.

6.1 Controlling a single magnetic shaker

- ◆ Turn the frequency selection knob (11) on the SHAKEMODUL (12) to OFF (Figure 1 and Figure 5).
- ◆ Plug the control line (7) of the TELESHAKE (4) into the control line connector (8) of the SHAKEMODUL (12). Tighten the knurled screw.
- ◆ Plug the mains cable of the SHAKEMODUL (12) into a socket outlet.
- ◆ Insert the computer plug of the RS232 connecting cable into the COM socket of the PC.
- ◆ Insert the control unit plug of the RS232 cable into the red jack socket (10) of the control unit (Figure 5).
- ◆ Mount the microtitre plate on the TELESHAKE (4) (see chapter 5).

6.2 Controlling several magnetic shakers (up to 14 units)

⇒ **Connecting the first SHAKEMODUL (12):**

- ◆ Turn the frequency selection knob (11) on the SHAKEMODUL (12) to OFF (Figure 5).

- ◆ Plug the control line (7) of the TELESHAKE (4) into the control line connector (8) of the SHAKEMODUL (12). Tighten the knurled screw.

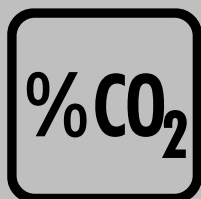

INFORMATION

When operating multiple TELESHAKES (4), the socket strip should be arranged so that the plug cables run at right angles to the strip.

- ◆ Plug the mains cable of the first SHAKEMODUL (12) into the first socket of the socket strip (Figure 6).
- ◆ Insert the computer plug of the RS232 connecting cable (15) into the COM socket of the PC.
- ◆ Insert the control unit plug of the RS232 connecting cable (15) into the red jack socket (10) of the first SHAKEMODUL control unit (12) (Figure 5 and Figure 6).

⇒ **Connecting additional SHAKEMODULS (12):**

- ◆ Turn the frequency selection knob (11) on the SHAKEMODUL (12) to OFF (Figure 5).
- ◆ Plug the control line (7) of the TELESHAKE (4) into the control line connector (8) of the SHAKEMODUL (12). Tighten the knurled screw.
- ◆ Plug the mains cable of the first SHAKEMODUL (12) into the first socket of the socket strip (Figure 6).

Repeat these steps until the desired number of TELESHAKE units (4) with SHAKEMODULS (12) have been plugged into the socket strip. You may control a maximum of 14 units from one RS232 interface.

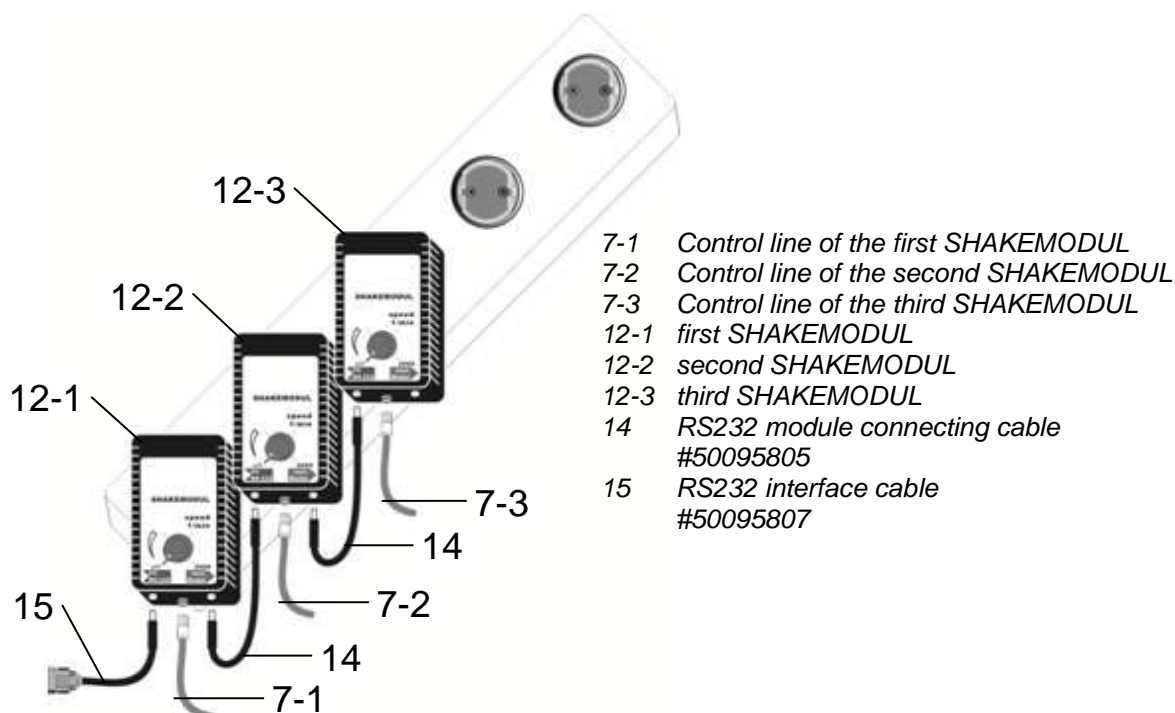
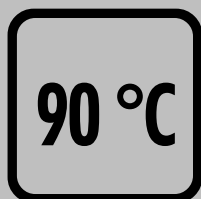

Figure 6: Controlling several SHAKEMODULS

⇒ **Interconnecting several SHAKEMODULS (12):**



CAUTION

Carefully interconnect the SHAKEMODULS (12) with the module connecting cables (14).

- ◆ Use the module connecting cable (14) to connect the blue jack socket (9) of the first SHAKEMODUL (12) to the red jack socket (10) of the second SHAKEMODUL (12) (Figure 6).
- ◆ Use another module connecting cable (14) to connect the blue jack socket (9) of the second SHAKEMODUL (12) to the red jack socket (10) of the third SHAKEMODUL (12).
- ◆ Continue in the same manner until all SHAKEMODULS (12) are connected.

The blue jack socket (9) of the last SHAKEMODUL (12) of the chain will remain open. The SHAKEMODUL control program (12) will address each unit automatically. The SHAKEMODUL (12) to which the RS232 connecting cable (15) is connected is automatically considered Unit 1, the next one in line is Unit 2, and so on. The control program also recognizes which SHAKEMODUL (12) has an open blue jack socket (9) and uses the last unit number to address this unit.

7 Maintenance and cleaning

The TELESHAKE magnetic shaker (4) is maintenance-free.

Regularly clean the TELESHAKE (4) and SHAKEMODUL (12) surfaces with a moistened cloth.

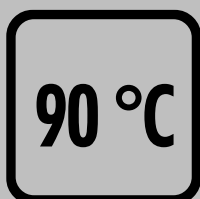

CAUTION

Use only water for cleaning. Do not use caustic liquids.

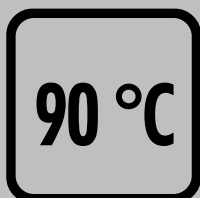

CAUTION

In case of repair, the equipment must only be opened by an authorized service agent.

In case of necessity to repair the equipment, it should be returned to an authorized servicing agent. The equipment must be clean and free from harmful substances.

To avoid transport damages during the shipment, please send the equipment correctly packed in the original packing.

Please always enclose the filled out return delivery note.

If necessary ask for the return delivery note at **Thermo Electron LED GmbH** (address: see inside of the cover sheet).

In case of ordering spares, please state equipment type and serial number.

You can obtain further technical documents (e.g. circuit diagrams, board data) for your engineers by contacting the address on the inside of the cover sheet.

8 Troubleshooting

- ⇒ **If the TELESHAKE magnetic shaker (4) does not shake:**
- ◆ Make sure that the control line (7) is properly connected.
 - ◆ Make sure that the shaker platform can move freely (e.g. no contact with other objects or walls).
 - ◆ If the shaking frequency is very high or the microtitre plate is very heavy (1):
Reduce the shaking frequency. Check whether the TELESHAKE (4) works correctly now.
If the filled microtitre plate (1) has a weight of more than 200 g, the maximum rated shaking frequency of 2,000 rpm may not be attainable.
- ⇒ **If the TELESHAKE magnetic shaker (4) does not shake when controlled via the RS232 interface:**
- ◆ Make sure that the frequency selection knob (11) of the SHAKEMODUL (12) is set to OFF.
 - ◆ Make sure that the RS232 connecting cable (15) is properly connected.
 - ◆ Make sure that all module connecting cables (14) are properly connected.

9 Technical specifications

Technical specification magnetic shaker TELESHAKE

TELESHAKE			Technical specifications
Order No.	without control unit incl. control unit	Version EU Version AU Version UK Version JP Version US	50134882 50094320 50095892 50095890 50095894 50094321
Number of microtitre plates			1
Drive power		W	< 3
Rotation speed range		rpm	100 – 2,000
Amplitude		mm	2.2
Centric position precision		mm	± 0.1
Dimensions (W x D x H)		mm	146 x 103 x 39
Weight		g	2000
Maximum shaker platform load		g	500
Design			remote-controlled
Housing material			Aluminium / brass
Protective system (EN 60529)			IP 3
Permissible operating conditions			+5 °C to +80 °C at max. 80 % relative humidity
Permissible storage condition			-40 °C to +80 °C at 10% to 95 % relative humidity 500 to 1,060 hPa barometric pressure

Subject to technical alterations

9 Technical specifications

Technical specification control unit SHAKEMODUL

SHAKEMODUL		Technical specifications
Order No.	Version EU Version AU Version UK Version JP Version US	50134886 50135010 50134887 50134889 50134888
Input voltage/frequency	VAC/Hz	EU: 230/50-60 US: 115/50-60 UK: 230/50-60 JP: 100/50-60 AU: 240/50-60
Output voltage	VDC	12
Dimensions (W x D x H)	mm	65 x 100 x 85
Weight	g	500
Control interface		RS232
RS232 protocol definition		Description # 50134793
Permissible operating conditions		+10 °C to +40 °C at 30 % to 75 % relative humidity 700 to 1,060 hPa barometric pressure
Permissible storage conditions		-40 °C to +70 °C at max. 80 % relative humidity 500 to 1,060 hPa barometric pressure
Protective system (EN 60529)		IP 20
RS232 module cable		# 50095805
RS232 interface cable		# 50095807

Subject to technical alterations

10 Warranty

The magnetic shakers have a modular construction and offer the greatest possible degree of trouble-free operation, thanks to their maintenance-free stirring and magnetic drives.

If despite our strict quality controls a system component should ever fail to work perfectly, it can be repaired or replaced by our after-sales service without difficulty. Please retain your invoice, which will be needed when presenting any warranty claims.